

Wave Phenomena

I. Waves in One Dimension: Fundamental Concepts 3

II. Waves in Higher Dimensions 17

GLOSSARY

Amplitude: Local peak amplitude of a wave form; function A .

Dot product: $\mathbf{k} \cdot \mathbf{x} = k_1x_1 + k_2x_2 + k_3x_3$ in three dimensions, $k_1x_1 + k_2x_2$ in two dimensions.

Frequency: Temporal (local) rate at which a wave repeats its fundamental form; ω in the units of radians/second, $f = \omega/2\pi$ in the units cycles/second or hertz.

Group speed: Speed at which energy propagates; in one dimension, $|d\omega/dk|$; in higher dimensions, $|\nabla_{\mathbf{k}}\omega(\mathbf{k})|$.

Group velocity: Velocity vector which describes the magnitude and the direction of the propagation of energy; in one dimension, $d\omega/dk$; in higher dimension, $\nabla_{\mathbf{k}}\omega(\mathbf{k})$.

Incident wave: Wave on one side of a surface whose propagation is toward the surface.

Period: Elapsed time for one cycle of a wave; $2\pi/\omega = 1/f$.

Phase: The function $kx - \omega t$ or $\mathbf{k} \cdot \mathbf{x} - \omega t$ in the wave forms above.

Phase speed: Speed at which crests of a wave propagate; in one dimension, $|\omega/k|$; in higher dimensions, $|\omega|/k$, with k being the magnitude of the wave vector, \mathbf{k} .

Phase velocity: Both speed and direction at which wave crests propagate; $\hat{k}\omega(\mathbf{k})/k$.

Rays: Trajectories along which the constituent components of a wave –wave vector, frequency, phase, and energy–propagate.

Reflected wave: Wave arising at a surface of discontinuity (interface \leftrightarrow reflector) in the propagation parameters of a medium; this wave propagates on the same side of the interface as the incident wave.

Refracted wave: Wave arising at a surface of discontinuity (interface) in the propagation parameters of a medium; this wave propagates on the opposite side of the interface from the incident wave, and the propagation direction of this wave and the propagation direction of the incident wave satisfy Snell's law.

Snell's law: Law relating the directions of incidence and refraction of a wave at an interface [See Eq. 79.]

Stationary phase: Method for obtaining an approximation (asymptotic expansion) of an integral with an oscillatory factor, such as a Fourier superposition integral.

Wave length: Fundamental length scale over which a wave repeats itself; $2\pi/k$.

Wave number: Spatial rate at which cycles of a wave occur; coefficient k ; for the higher dimensional case, k is the magnitude of \mathbf{k} .

Wave vector: $\mathbf{k} = (k_1, k_2, k_3)$ in three dimensions; (k_1, k_2) in two dimensions; the notation (k_x, k_y, k_z) is also used.

1 Introduction

The phenomenon of wave motion is the primary mechanism by which a disturbance transfers energy over a distance in a medium. The propagation of this energy is thought of as being wavelike when it can be characterized by some feature (e.g., a crest) that is at least partially preserved as recognizable during the propagation over a distance or time interval. The most common wave phenomena are acoustic (sound), elastic (seismic), electromagnetic (light, radio, or television), or gravitational (surface water) waves; there are many others. Certain features of the propagation of waves are common to all wave phenomena, no matter what the medium.

This article is a partial description of the broad class of common features of wave phenomena as seen in their mathematical description. Where it is necessary to distinguish between linear and nonlinear waves, this discussion is further limited to the former. Even a textbook-sized discussion would inevitably omit some common features of waves—linear and nonlinear—because of the breadth of the subject. This, then, is one author's choice of a fundamental subset of common features of linear wave phenomena.

The discussion starts with one dimensional wave propagation. We start with definitions of the features of a single sinusoidal wave—amplitude, wave length, wave number, period, frequency. We then proceed to a simple superposition of two waves to introduce the distinction between phase speed/velocity and group speed/velocity.

These simple ideas then become a point of departure for the discussion of Fourier superposition. This is a powerful tool for deriving analytical representations of solutions of wave equations in homogeneous media. It further has application to provide exact representation in some cases of heterogeneous media and, beyond that, it provides approximate representations of wave fields in an even larger class of heterogeneous media.

However, when synthesizing waves over a continuum of wave numbers, the identification of phase velocity and group velocity is obscured by the representation. In order to recapture those features of wave propagation, the method of stationary phase is introduced. It is shown that this approximation of the wave provides a conceptually simplified interpretation of the more complicated Fourier synthesis. In this simplified representation, the phase and group velocities of the individual elements of the Fourier synthesis again become apparent, but this representation is an approximation of the original integral. We present a numerical example to demonstrate the reliability of this approximation under appropriate dimensionless constraints on the physical parameters of the wave being represented.

The same development is repeated for higher dimensional wave propagation. In this case, there are additional features due to the dimensionality: the wave number is replaced by a

wave vector; directionality plays an important role in the identification of phase and group velocities. Interestingly, these two velocities need not co-align.

Again, Fourier synthesis provides a means for describing more complicated waves and *multidimensional* stationary phase provides a means of approximating those waves that admits simpler interpretation in terms of wave packets propagating with their own group velocity, while elements at specific wave vectors within the group travel with their own individual phase velocity.

The article closes with discussion of reflection and refraction of a three dimensional plane wave by a planar reflector.

2 Waves in One Dimension: Fundamental Concepts

As a specific example to picture in our minds, let us suppose that we are describing the vertical displacement of points on a straight line (a string) as a function of transverse location (x) on the line and time (t). We shall denote the vertical displacement by $u(x, t)$. As a simple example of that displacement, let us suppose that u is given by

$$u(x, t) = A \cos(kx - \omega t). \quad (1)$$

In this equation, A , k , and ω are constants; for now, they are all positive constants. (Note that we could have as easily begun our discussion using a sine function instead of a cosine function.)

2.1 Amplitude, phase, wavelength, wave number, period, and frequency

For each fixed value of t , the graph of $u(x, t)$ in the (x, u) -plane is a cosine function of maximum height A called the amplitude of the wave. The argument of the cosine function $[kx - \omega t]$ is called the *phase* of the wave. The peaks or crests of the cosine function, that is, the points where $u(x, t) = A$, occur whenever

$$\begin{aligned} kx &= 2n\pi + \omega t, \\ n &= \dots, -2, -1, 0, 1, 2, \dots \end{aligned} \quad (2)$$

The peaks are separated by a distance over which kx increases by 2π , namely a distance

$$\lambda = 2\pi/k \quad (3)$$

called the *wave length* of the wave represented by $u(x, t)$ (Figure 1). The constant k is called the *wave number*.

For fixed x and variable t , the graph of $u(x, t)$ in a (t, u) -plane is analogous to what we have just described. The amplitude of u is again given by A , but now the peaks of the cosine function at fixed x occur at the times

$$\begin{aligned} \omega t &= 2m\pi + kx, \\ m &= \dots, -2, -1, 0, 1, 2, \dots \end{aligned} \quad (4)$$

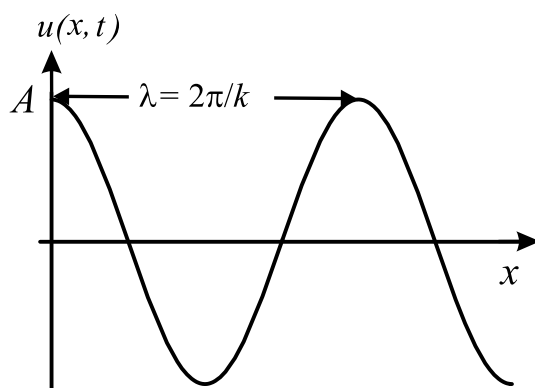
Figure 1: The wave of Eq. (1) for fixed t .

The elapsed time between peaks at fixed x is such that the increment in ωt is equal to 2π , given by a time

$$T = 2\pi/\omega \quad (5)$$

called the *period* of the wave motion. The constant ω is called the *frequency* (Figure 2).

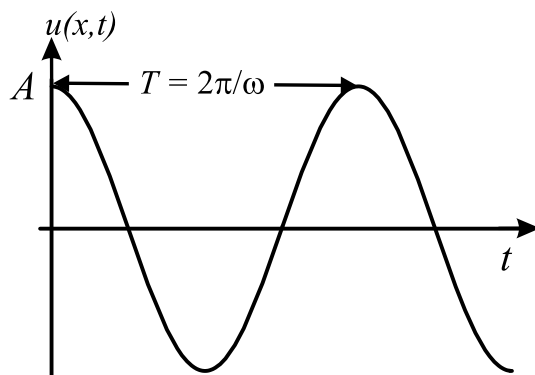
Figure 2: The wave of Eq. (1) for fixed x .

Of course, we can look at the wave as a function of x and t simultaneously; see Figure 3. For this example, we have chosen $\omega = 2k$. This manifests itself as an apparent compression of the wave crests in the t -direction as compared to the density of the wave crests in the x -direction.

Now think of a vertical plane parallel to the $x-u$ -plane—a constant t -plane. This provides a snapshot, such as the one in Figure 1. Now consider moving that plane in the positive t -direction. From the figure, it should be apparent that each wave crest, each wave trough—in fact, every point of constant phase on the wave—moves in the positive x -direction, increasing x . This is a manifestation of positive phase speed, a subject of the next section.

The units of the phase function in Eq.(1) are *radians*. Therefore, the units of the wave number k are radians per unit length, while the units of the frequency ω are radians per unit time. Because there are 2π radians per period or cycle, it is sometimes more convenient to use units of frequency and wave number that are scaled by 2π , which is the number of

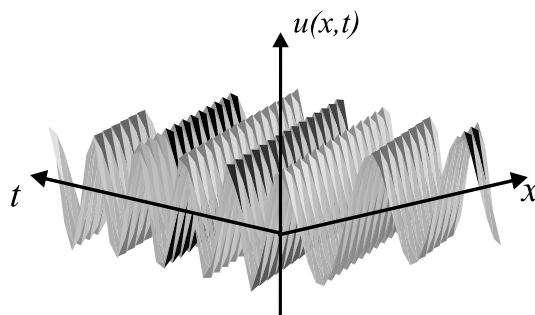

Figure 3: A space-time image of the wave of Eq. (1).

radians in one period or cycle. Thus, the new variables have the dimensions of cycles per unit time or cycles per unit length. These variables are often denoted by f and f_x , defined by

$$\omega = 2\pi f \text{ and } k = 2\pi f_x, \quad (6)$$

respectively. The units of f are reciprocal time, often referred to as cycles per unit time, and the units of f_x are reciprocal length, referred to as cycles per unit length. When the time unit is seconds, the units of f are called hertz (hz). In these units, the temporal period and the frequency are reciprocals of one another, as are the spatial period and wave number, now often referred to as the spatial frequency.

2.2 Phase speed and group speed

Having examined the function $u(x, t)$ both for fixed t and fixed x , we are now prepared to consider u when both x and t are allowed to vary. In particular, let us consider the graph in the (x, u) -plane. The peaks of u , as well as all the points of constant phase, and hence constant u , will move or propagate as time progresses. The rate (v_ϕ) at which a point of constant phase will move is readily determined by setting the phase equal to a constant and differentiating that relationship with respect to t :

$$kx - \omega t = \text{const.}, \quad v_\phi = dx/dt = \omega/k. \quad (7)$$

Thus, we see that the points of constant phase move with the speed ω/k , called the *phase speed*. When ω and k have the same sign, this motion is to the right; when ω and k have opposite signs, the motion is to the left.

The wave $u(x, t)$ defined by Eq. (1) is *periodic*, having exactly the same shape in every interval whose length is given by the wave length λ . It is also periodic in t , having the same shape in every temporal interval given by the period T . In reality, no wave can be periodic over all space and time. However, many wave phenomena are periodic on intervals of sufficient length (many multiples of λ) and/or for intervals of sufficient time (many multiples of T) to be considered periodic for all practical purposes. (A simple example would be alternating current in a transmission line or waveguide.) Indeed, the transmission of information in an otherwise periodic wave depends on local variations in amplitude (amplitude modulation) or phase (frequency modulation).

In many cases, the phase velocity v_ϕ varies with ω and k . Typically, the physics of a particular problem and its attendant mathematical model impose a relationship between k and ω , called a *dispersion relation*

$$\omega = \omega(k). \quad (8)$$

Except in the special case in which $\omega = ck$, with c independent of k , different frequencies will propagate at different speeds determined by the dispersion relation and the definition of v_ϕ in Eq. (7).

We next consider waves of two nearby frequencies and the same amplitude and ask how the composite wave, which is the sum of the two, will propagate. Thus, let us introduce the function

$$u(x, t) = A \left[\cos(k^+x - \omega^+t) + \cos(k^-x - \omega^-t) \right]. \quad (9)$$

In this equation, we have used k^\pm and ω^\pm as shorthand notations for

$$\begin{aligned} k^\pm &= \bar{k} \pm \Delta k; & \omega^\pm &= \bar{\omega} \pm \Delta\omega \\ & & &\approx \bar{\omega} \pm (d\omega/dk)\Delta k \\ \bar{k} &= (k^+ + k^-)/2; & \bar{\omega} &= \omega(\bar{k}). \end{aligned} \quad (10)$$

By using the appropriate trigonometric identity, we can rewrite the sum of cosine functions in Eq. (9) as a product of cosines:

$$u(x, t) = 2A \cos(\Delta kx - \Delta\omega t) \cos(\bar{k}x - \bar{\omega}t). \quad (11)$$

Implicit in our notation is the assumption that Δk is much smaller than \bar{k} , so that the wavelength $2\pi/\Delta k$ associated with the first cosine factor in this equation is much larger than the wavelength $2\pi/\bar{k}$ associated with the second cosine factor. Thus, the first cosine factor acts as a slowly varying amplitude modulator, varying the amplitude $2A$, which is the sum of the two amplitudes of the constituent waves of $u(x, t)$. The wave of average wave number \bar{k} and average frequency $\bar{\omega}$ travels through the envelope at its phase speed $v_\phi = \bar{\omega}/\bar{k}$, while the envelope itself moves at its own speed, associated with the differentials Δk and $\Delta\omega$,

$$v_g = \Delta\omega/\Delta k \approx d\omega/dk|_{k=\bar{k}} \quad (12)$$

known as the *group speed*.

Suppose that v_ϕ and v_g are both positive. When $v_\phi > v_g$, the crests moving at the phase speed move forward through each wavelength of the packet created by the modulator of the amplitude; when $v_\phi < v_g$, the crests move backward through the packet. The former case—or more precisely, $v_\phi \geq v_g$ —is more typical, with v_g having an upper bound, the characteristic speed of the medium (e.g., sound speed, light speed, etc.) through which the wave propagates and v_ϕ having the characteristic speed as a lower bound.

In Figure 4, we show a sum of the two waves of Eq. (9). They are of unit amplitude with $\bar{k} = \pi$, $\Delta k = .05k$ and $t = 1$. Further, $\omega(k) = \sqrt{k^2 + \pi^2}$. The x -range here is 40

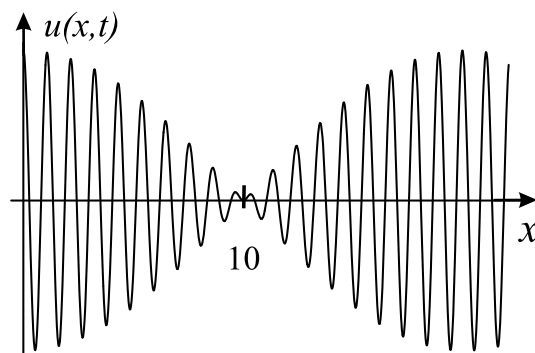

Figure 4: An example of Eq. (9) at $t = 0$.

units in the given length scale. Thus, we see twenty cycles of the high frequency wave over this range. On the other hand, the sum of the waves is equal to zero at $x = 20$, where $\Delta k * x = .05 * \pi * 20 = \pi$ and the arguments of the two cosine functions are out of phase by π , making the sum equal to zero. In Figure 5, we show the same wave at $t = 4.353$. The

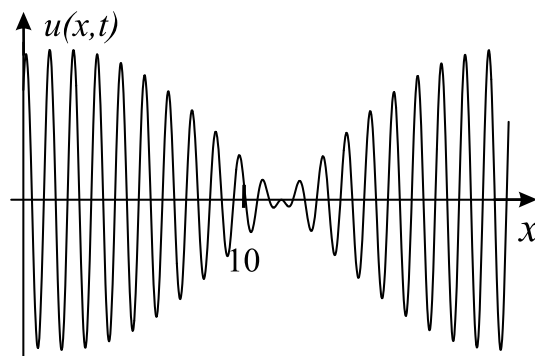

Figure 5: The same example of Eq. (9) as in Figure 4 at $t = 4.353$.

peaks and the zero of the envelope have moved forward and the peaks of the fast cycles do not occupy the same positions in the envelope. Actually, they have moved forward, as well.

An important feature of the group speed is that the *energy* of the wave residing in the waves numbers near \bar{k} will propagate at this speed. Thus, if a localized disturbance is created, it is the group speed that will determine how much time will elapse before this portion of the disturbance is observed at a distance.

2.3 Fourier superposition

These ideas extend in a natural way to the Fourier superposition of waves expressed as

$$u(x, t) = \frac{1}{2\pi} \int_{-\infty}^{\infty} A(k) \exp \{i [kx - \omega(k)t]\} dk. \tag{13}$$

In this equation, we think of $A(k) dk/2\pi$ as the amplitude of a wave with wave number k and frequency $\omega(k)$. The integration (summation) is then a superposition over all values of

k . The values of k for which $A(k)$ are nonzero are called the *spectrum* of the wave $u(x, t)$. The product $A(k) dk$ must have the same dimensions as u itself. Thus, $A(k)$ must have the dimensions of $u/\text{unit-length of } k$; that is $A(k)$ is a density, called the *spectral density* of the wave $u(x, t)$.

We have used the complex exponential for our Fourier superposition, but we assume that the amplitude function $A(k)$ is such that the resulting integral is real. For example, suppose that $\omega(k)$ were an odd function of k so that negative frequencies yielded an exponential function for negative k that is the complex conjugate of its values for positive k . Then, when the real part of $A \operatorname{Re}\{A\}$ is an even function of k and the imaginary part of $A \operatorname{Im}\{A\}$ is an odd function of k , $u(x, t)$ would be real. Under other assumptions on $\omega(k)$, other constraints on A would make the resulting integral real. Alternatively, we could simply require that u be defined by the real part of the integral on the right.

2.4 Stationary phase formula

Let us suppose in Eq. (13) that $A(k)$ is nonzero only for values of $|k|$ larger than some minimum value, say k_0 . We define $\omega_0 = |\omega(k_0)|$ as the associated frequency. We assume that $|\omega(k)| \geq \omega_0$ whenever $|k| \geq k_0$. We then rewrite the exponent in Eq. (13) as

$$kx - \omega(k)t = \omega_0 t [kx/(\omega_0 t) - \omega(k)/\omega_0] \quad (14)$$

In this form, we may think of $\omega_0 t$ as playing the role of a dimensionless parameter to be denoted by Λ (see below) and the expression $kx/(\omega_0 t) - \omega(k)/\omega_0$ as a dimensionless phase function with independent variable k . We could as well make the independent variable dimensionless by scaling k by k_0 ; that is $k/k_0 = \eta$. Below, we will describe the analysis of integrals such as Eq. (13) in terms of such dimensionless variables.

In practice, the parameter Λ is often large. We offer the following interpretation of this requirement. Let us denote by T_0 the period associated with the minimum frequency ω_0 ; that is, $T_0 = 2\pi/\omega_0$. Then $2\pi t/T_0$ must be large. That is, the observation time multiplied by 2π must be “many” periods at the minimum frequency. Most often, this requirement is stated in a form that puts the burden on the frequency rather than the time. That is, the frequency is such as to make $\omega_0 t$ large. Thus, we may think of large Λ as characterizing *high frequency*. While we have described this as being “many” periods, note that the factor of 2π in the expression, $2\pi t/T_0$, provides some help in this matter. In practice, one often finds that

$$2\pi t/T_0 \geq \pi \quad \Rightarrow \quad t \geq T_0/2$$

is good enough! That is, the asymptotic approximation that is described below provides a “reasonably” accurate description of the integral, Eq. (14), for times beyond a half period.

By scaling out the factor $k_0 x$, we could have obtained an interpretation in terms of propagation over many units of inverse wave number instead of many periods. In either case, we must only require that, after scaling, the dimensionless derivatives should be bounded and should not be comparable in magnitude to the dimensionless large parameter Λ . That is, the remaining phase function should be “slowly varying” when compared to Λ .

In this limit we can approximate the integral in Eq. (13) by the method of stationary phase. We state the basic result for one dimensional integrals here. In the following chapter, the result for multidimensional integrals will be presented. Suppose that

$$I = \int f(\eta) \exp \{i\Lambda\Phi(\eta)\} d\eta \quad (15)$$

with Λ being a large parameter, in practice, at least three or π , as was used in the discussion above. Then the value of the integral will be dominated by its contributions from the neighborhood of certain points, say η_j , $j = 1, 2, \dots, n$, called stationary points, where the first derivative vanishes.

$$d\Phi/d\eta = 0, \quad \eta = \eta_j, \quad j = 1, 2 \dots n. \quad (16)$$

When the second derivative at the stationary point does not vanish, the point is called a *simple stationary point*. In practice, it is most often the case that the stationary points are simple. Of course, the case of higher order stationary points (where a higher order derivative is the first nonvanishing derivative at the stationary point) occurs as well and leads to a rich theory of wave phenomena beyond the scope of the present discussion. We proceed under the assumption that the stationary points are simple. In this case, the integral I defined by Eq. (15) is approximated by

$$I \sim \sum_{j=1}^n \sqrt{\frac{2\pi}{|\Lambda\Phi''(\eta_j)|}} f(\eta_j) \times \exp [i\Lambda\Phi(\eta_j) + i(\pi/4)\text{sgn}(\Lambda)\text{sgn}(\Phi''(\eta_j))]. \quad (17)$$

This is the *stationary phase formula* for the case of a simple stationary point. In this equation, we have used prime (\prime) to denote differentiation with respect to η . The notation, $\text{sgn}(\Lambda)$, means “sign of Λ .” The symbol “ \sim ” is to be read as “is asymptotically equal to.” It means that the error approaches zero more rapidly than the terms of the sum, that is, more rapidly than a constant over $\sqrt{|\Lambda|}$, as $\Lambda \rightarrow \infty$. Usually the error is bounded by a constant over $|\Lambda|$ or a constant over $|\Lambda|^{3/2}$.

Despite the formal statement addressing the error only in the limit as $|\Lambda| \rightarrow \infty$, we repeat that in practice $|\Lambda|$ greater than three or π —use whichever is convenient—would seem to suffice. For example, when this asymptotic approximation is used to estimate the zeroeth order Hankel function of the first kind for its argument equal to three, that is, $H_0^{(1)}(3)$, the error turns out to be only about 6%, sufficiently small for a qualitative understanding of how the function in question behaves and even adequate for purposes of modeling of real world wave phenomena.

The method of stationary phase quantifies the following qualitative ideas about the integration of a function with a “rapidly varying” kernel, that is, a multiplier such as the exponential function, with real and imaginary parts each having intervals of positive function values closely adjacent to intervals of negative function values. When the amplitude function does not vary as rapidly as the kernel, the integral over a positive lobe tends to

cancel the integral over the adjacent negative lobe. The cancellation is slightly less when the rapid variation is diminished, that is, when the phase is stationary. The stationary phase formula then approximates the integral over an interval around such a stationary point. The resulting Eq. (18) states that the integral over the entire interval is dominated by contributions from the neighborhoods of the stationary points.

Below, we will apply the stationary phase formula to the integrals such as those in Eq. (13). We will not always bother to rescale that Fourier representation or to introduce a dimensionless variable of integration η . We shall proceed formally in our dimensional variables, with the understanding that a complete justification of our asymptotic approximation relies on an analysis such as the one presented here. Thus, we will apply the results of this section with η replaced by k and Λ set equal to unity.

2.5 Asymptotic analysis of Fourier superposition

We will now apply the method of stationary phase of the previous section to the integral in Eq. (13). To do so, we set

$$\Phi(k) = kx - \omega(k)t \quad (18)$$

and differentiate

$$\frac{d\Phi}{dk} = x - \frac{d\omega}{dk}t; \quad \frac{d^2\Phi}{dk^2} = -\frac{d^2\omega}{dk^2}t. \quad (19)$$

In accordance with Eq. (16), we set the first derivative equal to zero to determine the stationary points:

$$x = (d\omega/dk)t. \quad (20)$$

The function $d\omega/dk$ was defined above to be the group velocity (This derivative can be positive or negative.) at the given value of k . We see here that, for a given value of x and t , the stationary points are those k values for which the corresponding wave component would propagate at the group velocity $d\omega(k)/dk$ from the origin to the point x in time t . We remind the reader that the method of stationary phase provides an approximation to the integral over an interval around the stationary point. Thus, the condition of stationarity predicts that the packet of wave numbers around the stationary value will propagate at the group velocity of the stationary value. This theme will repeat itself in higher dimensions.

We now write the asymptotic approximation of Eq. (18) to the integral of Eq. (13) as

$$u(x, t) \sim \sum_{j=1}^n \frac{A(k_j)}{\sqrt{2\pi|\omega''(k_j)|t}} \times \exp\{i[k_j x - \omega(k_j)t - i(\pi/4)\text{sgn}(\omega''(k_j))]\}. \quad (21)$$

In this equation, the summation is to be carried out over the solutions of the equation of stationarity [Eq. (20)]. We see here that each term of the sum has the structure of the fundamental waveform of Eq. (1) except that the real valued amplitude and cosine functions have been replaced by a complex valued amplitude and complex exponential. That is,

asymptotically, the general Fourier superposition of elementary waves behaves locally like the elementary wave, except that the phase and group velocities of the elementary waves will vary both with position and time.

This observation suggests an alternative manner in which to interpret the result of Eq. (21). Let us fix the value of k . Then we think of the packet of wave numbers in the neighborhood of that k value as propagating at the group velocity $d\omega(k)/dk$ with amplitude and phase being given by the summand of Eq. (21) evaluated at k . For some applications, this interpretation is as useful as the actual evaluation at a given (x, t) as defined by the summation in Eq. (21). Indeed, this interpretation provides a quantification of the definition of a wave. We see here a phase function whose crests propagate as time progresses, while the amplitude of the wave, providing the height of the crests, also varies as time progresses.

It may not be apparent why the propagation originates from the origin for this example. To understand why this is so, let us consider the wave represented by Eq. (13) at $t = 0$:

$$u(x, 0) = \frac{1}{2\pi} \int_{-\infty}^{\infty} A(k) \exp(ikx) dk. \quad (22)$$

Let us rewrite this integral in terms of the dimensionless variable $\eta = k/k_0$:

$$u(x, 0) = \frac{k_0}{2\pi} \int_{-\infty}^{\infty} A(\eta k_0) \exp(ik_0 x \eta) d\eta. \quad (23)$$

As the product $k_0 x$ approaches infinity, the integral will approach zero under relatively mild assumptions on the amplitude A . (The Riemann Lebesgue lemma guarantees this result if $|A(k)|$ is integrable.) Thus, we might expect that $u(x, 0)$ will be small for large values of $k_0 x$ and will be substantially different from zero only in some interval around the origin in which $k_0 x$ is not large. Consequently, to the order of approximation consistent with our asymptotics, the propagation of $u(x, t)$ initiates from the neighborhood of the origin in x . In application, the Fourier representation may well contain other terms in the phase that distribute the initiation point of different components of the wave $u(x, t)$ over a range of x values. For example, we might replace $A(k)$ in Eq. (13) by $A(k) \exp[i\phi_0(k)]$. We would then add derivatives of ϕ_0 to the right sides in Eq. (19). In particular, $-\phi_0'(k)$ would replace the origin as the initial value of x in Eq. (20). However, even in those cases, the propagation of the constituent elements of $u(x, t)$ would still be governed by the group velocity, as was the case for this simple example.

2.6 An example of dispersive wave propagation

We will discuss a simple example of wave propagation that will exhibit some of the features we have described in the previous section.

Let us suppose that $u(x, t)$ is a solution of the following initial value problem:

$$\begin{aligned} \frac{\partial^2 u}{\partial t^2} - c^2 \frac{\partial^2 u}{\partial x^2} + b^2 u &= 0, & t > 0, & \quad -\infty < x < \infty \\ u = 0, \quad \frac{\partial u}{\partial t} &= \delta(x), & t = 0. \end{aligned} \quad (24)$$

The function $\delta(x)$ is the Dirac delta function.

We will solve the problem for u by Fourier transform. Thus, we introduce

$$\tilde{u}(k, t) = \int_{-\infty}^{\infty} u(x, t) \exp(-ikx) dx. \quad (25)$$

By applying Fourier transform to the problem of Eq. (25), we obtain the following problem for \tilde{u} :

$$d^2\tilde{u}/dt^2 + (c^2k^2 + b^2)\tilde{u} = 0, \quad t > 0 \quad (26)$$

$$\tilde{u} = 0, \quad d\tilde{u}/dt = 1, \quad t = 0.$$

We leave it to the reader to verify that the solution to this initial value problem is

$$\tilde{u}(k, t) = \frac{\exp[i\omega(k)t] - \exp[-i\omega(k)t]}{2i\omega(k)}, \quad (27)$$

$$\omega(k) = \sqrt{c^2k^2 + b^2}.$$

In this equation, we have allowed a slight abuse of notation. There are really two waves represented here; one with $\omega = \omega(k)$ and the other with $\omega = -\omega(k)$. Because the two dispersion relations define ω with only a difference in sign, we have introduced only one function $\omega(k)$.

We take the inverse Fourier transform of the solution in Eq. (28) to obtain an integral representation of the solution to the problem of Eq. (25):

$$u(x, t) = \frac{1}{4\pi i} \sum_{\pm} \pm \int_{-\infty}^{\infty} \frac{\exp[i\Phi_{\pm}(k, x, t)]}{\omega(k)} dk \quad (28)$$

where

$$\Phi_{\pm}(k, x, t) = kx \mp \omega(k)t = kx \mp \sqrt{c^2k^2 + b^2}t.$$

Furthermore, the summation notation means that we add together the results of the upper and lower signs.

As a basis for comparison, it is worthwhile at this juncture to specialize the result here to the case in which there is no dispersion. That is, we consider the special case in which $b = 0$ and $\omega = \pm ck$. We then find that the solution of Eq. (28) becomes

$$u(x, t) = \frac{1}{4\pi ic} \sum_{\pm} \pm \int_{-\infty}^{\infty} \frac{\exp[ik(x \mp ct)]}{k} dk \quad (29)$$

$$= \begin{cases} 1/2c, & |x| < ct \\ 0, & |x| > ct \end{cases} = \frac{1}{2c} H(ct - |x|).$$

In the final expression, $H(x)$ is the Heaviside function, defined to be equal to zero for $x < 0$ and equal to one for $x > 0$. Its value at $x = 0$ is unimportant, however, if it is obtained by

Fourier inversion, the value at $x = 0$ will be equal to one-half. The Fourier transform in this equation can be carried out by standard techniques of complex contour integration or the result may be found in a standard table of Fourier transforms. We see here that the initial impulse has caused the value of $u(x, t)$ to “jump” from zero to the value $1/2c$ everywhere on the “characteristic” interval $(-ct, ct)$ and to remain there for all time. One can think of the initial data, nonzero only at the origin, as propagating to the right and left at speed c and affecting the value of $u(x, t)$ everywhere inside the characteristic interval.

Let us now return to the dispersive wave represented by Eq. (28). This wave is by no means as easy to analyze because of the complicated form of the integrand. We will therefore resort to our asymptotic method in an attempt to reinterpret this solution, at least asymptotically, in terms of simpler functions.

This example provides us an excellent opportunity to consider the effects of scaling to dimensionless variables, as discussed in Sec. 1.3. Thus, we introduce the new variable of integration η , defined by

$$\eta = ck/b. \quad (30)$$

As a check on dimensions, we note that c has the dimensions of length/time, while b must have the dimensions of 1/time for each term of the original Eq. (25) to have the same dimensions. Since k has the dimension of inverse length, η is indeed dimensionless.

In terms of η , the relevant functions of the integrand in Eq. (30) take the following form:

$$\begin{aligned} \omega(k)t &= bt\sqrt{\eta^2 + 1}, & kx &= \eta xb/c \\ \Phi_{\pm}(k, x, t) &= bt\Psi_{\pm}(\eta, x, t) \\ \Psi_{\pm}(\eta, x, t) &= \left[\eta x/ct \mp \sqrt{\eta^2 + 1} \right]. \end{aligned} \quad (31)$$

We can see in this form that the large parameter emerges naturally as bt , that is, time measured in inverse units of a characteristic frequency of the original problem. Parenthetically, we note that this is also the minimum frequency of any Fourier component of the solution of Eq. (30). Furthermore, one can check that the maximum value of the η derivative of Ψ_{\pm} is $|x|/ct + 1$. (It is more difficult to show from the representation of Eq. (28), but nonetheless true, that only values of $|x| \leq ct$ are of interest; otherwise the integral is identically zero.) At any distance, this bound on the derivative of Ψ_{\pm} approaches unity as time increases.

The asymptotic analysis of each term in the sum in Eq. (30) proceeds as in the general case. The phase speeds [Eq. (7)] and the group speeds [Eq. (12)] for the two waves are given by

$$v_{\phi} = \pm \frac{\sqrt{c^2 k^2 + b^2}}{k}; \quad v_g = \pm \frac{c^2 k}{\sqrt{c^2 k^2 + b^2}}. \quad (32)$$

We see here that the phase speeds are greater in magnitude than the speed c , while the group speeds are less in magnitude than c , for every finite value of k . Both have c as limit as $|k| \rightarrow \infty$. The magnitude of the group velocity $|v_g|$ is a monotonically increasing function of $|k|$. Thus, wave packets centered around lower wave numbers will propagate slower while wave packets centered around higher wave numbers will propagate faster. On the other hand, if one could pick out waves at a particular frequency/wave number pair, those of lower wave

number would have crests that propagate *faster* than those of higher wave number. In any case, we expect, then, that the shape of the initial data function will be distorted as time progresses.

We will carry out the stationary phase analysis on the phase functions Φ_{\pm} defined in Eq. (30). Thus, following the method described in Sec. 1.5, we calculate the first and second derivatives as in Eq. (19):

$$\frac{d\Phi_{\pm}}{dk} = x \mp v_g t; \quad \frac{d^2\Phi_{\pm}}{dk^2} = \mp \frac{c^2 b^2 t}{(c^2 k^2 + b^2)^{3/2}}. \quad (33)$$

We now consider the condition of stationarity [Eq. (20)] for this example:

$$x = \pm c^2 k t / \sqrt{c^2 k^2 + b^2}. \quad (34)$$

In many applications, it is not possible to invert this condition of stationarity to determine k as a function of x and t . In those cases, we content ourselves with a parametric solution of the form of Eq. (21) subject to the condition of Eq. (20). Indeed, in the discussion following those equations, we offered an interpretation of that representation of the solution. However, in this example it is possible to explicitly solve Eq. (34), and we now proceed to do so and thereby obtain an explicit asymptotic solution for this problem under the assumptions that bt is large.

In these equations, we see that for the upper sign (+), x and k must have the same sign at the stationary point, while for the lower sign (-), x and k must be of opposite signs. With this observation, we solve Eq. (34) for the stationary values of k , namely, $\pm k_{\text{stat}}$:

$$k_{\text{stat}} = bx / c \sqrt{c^2 t^2 - x^2}. \quad (35)$$

We see here that there are real solutions only for $|x| \leq ct$. In the limit of equality, the stationary point moves off to infinity and the entire approximation technique breaks down. In fact, using (35) to compute the second derivative in (33), we find that

$$\Phi_{\pm}''(\pm k_{\text{stat}}) = \mp \frac{(c^2 t^2 - x^2)^{3/2}}{c b t^2}. \quad (36)$$

In this dimensional form, the second derivative is seen to vanish in the limit, as $x \rightarrow ct$. In such a limit, the stationary phase formula is invalid. If we had followed through on the dimensionless form, using (30), then

$$bt \frac{d^2\Psi_{\pm}}{d\eta^2} = \mp bt \left[1 - \frac{x^2}{(ct)^2} \right]^{3/2}. \quad (37)$$

In this form, it is clear that our original guess at a large parameter, bt , must be tempered by the additional factor on the right. Thus, for $x = 0$, the second derivatives have magnitude bt , large enough to expect asymptotics to work by assumption. On the other hand, the method must break down near the front of propagation, where the last factor in this equation or the numerator of the previous equation is nearly equal to zero. There are more exotic asymptotic

expansions that describe that region, as well, but the discussion of such techniques is beyond the scope of this article.

We now calculate the functions in the general formula of Eq. (21) for the specific example of Eq. (28) using Eq. (35). The result of that calculation is

$$u(x, t) \sim \frac{(c^2t^2 - x^2)^{-1/4}}{\sqrt{2\pi bc}} \times \cos\left(\frac{b}{c}\sqrt{c^2t^2 - x^2} - \frac{\pi}{4}\right). \tag{38}$$

This result should be compared to the exact solution,

$$u(x, t) = \frac{1}{2c} J_0\left[\frac{b}{c}\sqrt{c^2t^2 - x^2}\right], \tag{39}$$

$$c^2t^2 \geq x^2.$$

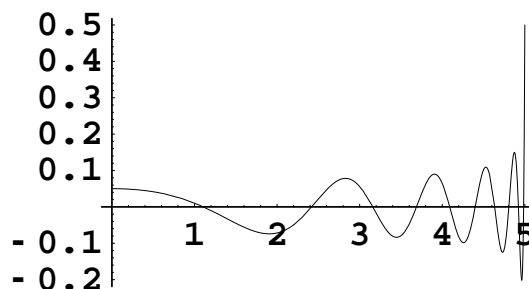

Figure 6: The exact solution for $t = 5$.

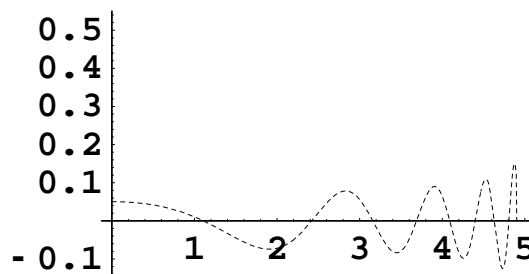

Figure 7: The asymptotic solution for $t = 5$.

Figure 6 shows the exact solution for $t = 5$, with $c = 1$, $b = 2\pi$ and $0 \leq x \leq 5$; Figure 7 shows the asymptotic solution for the same values, except that $0 \leq x \leq 4.98$. We see here that the character of the solution to the dispersive problem is quite different from the solution, Eq. (30), to the nondispersive problem. At each fixed x , $u(x, t)$ now oscillates in

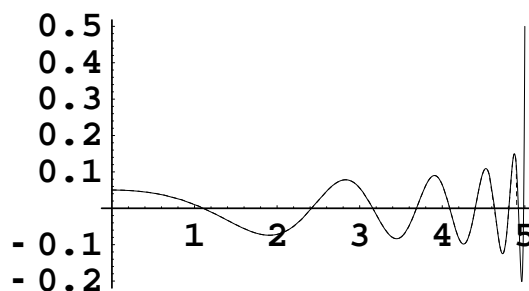

Figure 8: An overlay of the exact and asymptotic solutions for $t = 5$. The dashed curve is the asymptotic result, as in the previous figure.

time (as described by the cosine factor) while it decays as $1/\sqrt{t}$ as time progresses. For this problem, these are the consequences of variable propagation speed for the elements of the Fourier decomposition of the initial data.

Figure 8 shows an overlay of the two solutions. The agreement is apparent. Further, it can be seen that the wave slope increases with x . The reason is that the group velocity is a monotonic function of k . Thus, wave groups centered around large k -values propagate faster and therefore reside closer to the wave front. Larger k is related to more rapid variation and produces these larger slopes.

As noted above, we should expect good agreement even at $bt = \pi$. With $b = 2\pi$, that means $t = .5$. We show that agreement in Figure 9. Here, again, the asymptotic solution is restricted, in this case, to an upper bound of .48. At least at this empirically claimed lower bound for asymptotics, some separation between the exact solution—solid curve—and the asymptotic solution—dashed curve—is visible. In fact, the difference between these two functions varies from $-.015$ and $+.015$ over the range displayed in this figure. We cannot speak of a global percentage error for these functions that pass through zero. However, the error at $x = 0$ is 4.6%; the error at $x = .48$ is 3.8%. Furthermore, the shift in the zero crossing between the exact and the asymptotic solution is only 0.009. In applications, the accuracy of observed data rarely matches the accuracy of the asymptotic expansion, even at this claimed lower limit of the range of validity of the asymptotic expansion. Thus, the valid use of asymptotic approximations in applications is not a factor in the overall accuracy of the analysis of data.

In summary, we have seen in this example how a fairly complicated solution Eq. (28) to a dispersive wave equation [Eq. (25)] can be interpreted by asymptotic methods. In that interpretation [Eq. (38)] the distortion of the original waveform becomes more apparent and more easily recognized, especially when we compare this asymptotic solution to the exact dispersion free solution [Eq. (30)]. Furthermore, we again see the structure of a wave as described in the introduction. The equiphase points, including the crests and troughs of the wave, are determined by setting the argument of the cosine function in Eq. (38) equal to a constant. The amplitude is seen to vary both spatially and temporally. As time progresses at a fixed point x , the amplitude decays algebraically to zero, while points of constant amplitude propagate outward from the origin as time progresses.

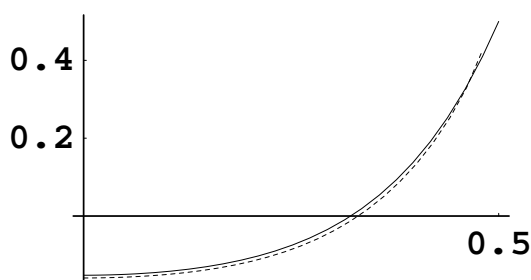

Figure 9: An overlay of the exact and asymptotic solutions for $bt = \pi$. The dashed curve is the asymptotic result.

3 Waves in Higher Dimensions

We will discuss here the extension of the concepts of the previous chapter to two and three dimensions. We remark, however, that in theory there is no reason to limit our discussion to three dimensions.

We will require a notation that allows us to refer to points in two- or three-dimensional space. Thus, let us introduce the boldfaced symbol, \mathbf{x} , to denote a point or vector in two or three dimensions. For the two-dimensional case, the coordinates of the point or the components of the vector will be (x_1, x_2) , while in three dimensions, x will denote the point or vector (x_1, x_2, x_3) . Many of the ideas we will express here will be independent of the number of dimensions.

Given two vectors \mathbf{x} and \mathbf{k} , we will denote by $\mathbf{k} \cdot \mathbf{x}$ the *dot product* of the two vectors, defined by

$$\mathbf{k} \cdot \mathbf{x} = \sum_{j=1}^m k_j x_j \quad (40)$$

with m being the dimension. We will denote by x the magnitude of the vector \mathbf{x} , that is,

$$x = (\mathbf{x} \cdot \mathbf{x})^{1/2}. \quad (41)$$

We will also use the notation $(\hat{\mathbf{x}})$ to denote the unit vector in the direction of \mathbf{x} , that is,

$$\hat{\mathbf{x}} = \mathbf{x}/x. \quad (42)$$

With this notation in place, we can begin our discussion of waves in higher dimensions.

3.1 Plane waves: Phase velocity and group velocity

We will consider now the extension of the concepts of Sec. 1 to higher dimensions. Instead of considering the real periodic function in Eq. (1), or its alternate in which the cosine function is replaced by a sine function, we will consider here the complex exponential

$$u(\mathbf{x}, t) = A \exp [i(\mathbf{k} \cdot \mathbf{x} - \omega t)]. \quad (43)$$

It is to be understood that the wave we are considering is the real part of the function $u(\mathbf{x}, t)$ or a real superposition of such functions.

In two dimensions, the function $u(\mathbf{x}, t)$ might be thought of as the vertical displacement of a membrane or the vertical displacement of the surface of a pool of water. These are simple extensions of the concept of the vertical displacement of a string, suggested in the previous section.

For the three-dimensional case, such easily visualized wave phenomena are not available. Perhaps the easiest characterization in three dimensions might be the pressure variations or density variations of a compressible fluid, such as air. That is, one might think of sound waves. More generally, $u(\mathbf{x}, t)$ might represent one component of the motion of particles of an elastic medium or one component of the electric or magnetic vectors of electromagnetic propagation.

In any case, we will proceed to introduce the basic concepts of wave phenomena in higher dimensions in the context of the simple function given by Eq. (43) and its generalizations analogous to those introduced in the discussion of wave phenomena in one dimension.

Let us first consider the question of peaks of the real part of the wave of Eq. (43). These peaks are located at the positions

$$\begin{aligned} \mathbf{k} \cdot \mathbf{x} &= 2n\pi + \omega t, \\ n &= \dots, -2, -1, 0, 1, 2, \dots \end{aligned} \quad (44)$$

For fixed t , a specific peak (fixed n) occurs everywhere on a line in two dimensions or on a plane in three dimensions. In either two or three dimensions, the wave represented by Eq. (42) is called a *plane wave*. The inclination of this plane is given by the unit normal $\hat{\mathbf{k}}$. The normal distance of the plane from the origin is given by $(2n\pi + \omega t)/k$, with k now denoting the magnitude of \mathbf{k} . Indeed, any constant value of the phase occurs on a plane with the same features, except that the distance from the origin is determined by the specific value of the phase rather than the value $2n\pi$. All of these planes are parallel (Figure 10).

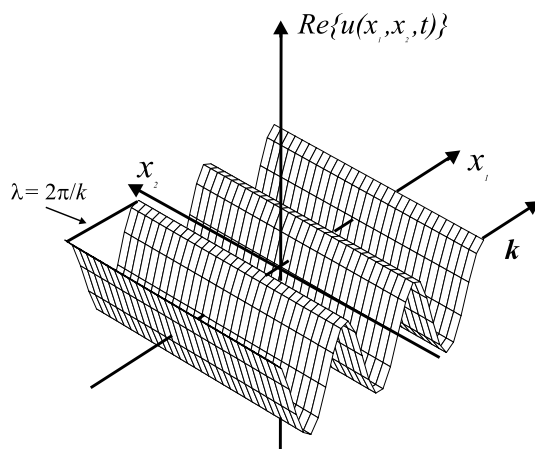

Figure 10: A snapshot at fixed time of a two-dimensional plane wave.

At fixed time, the normal distance between the planes of two peak values of $u(\mathbf{x}, t)$ is

given by

$$\lambda = 2\pi/k. \quad (45)$$

Thus, we again denote by λ the wavelength of the wave represented by $u(\mathbf{x}, t)$. The scalar k is again called the wave number. The vector \mathbf{k} is called the *wave vector*.

For fixed \mathbf{x} , the elapsed time between two peaks of $\text{Re } u$ in Eq. (43) is given by

$$T = 2\pi/\omega. \quad (46)$$

As in the one-dimensional case, we call T the period of the wave and ω the frequency.

As time progresses, we can think of a plane of peak values of $\text{Re}\{u(\mathbf{x}, t)\}$ as defined by Eq. (43) (or any plane of constant phase) as propagating normal to itself. It will propagate in the direction of $\hat{\mathbf{k}}$ when ω is positive or opposite to the direction of $\hat{\mathbf{k}}$ when ω is negative. The speed at which the plane propagates can be determined by calculating how the point on the normal through the origin propagates. That is, we set

$$\mathbf{x} = \hat{\mathbf{k}}x \text{sgn}(\omega) \quad (47)$$

and then replace the requirement of Eq. (43) by

$$\begin{aligned} kx \text{sgn}(\omega) &= 2n\pi + \omega t \\ n &= \dots, -2, -1, 0, 1, 2, \dots, \\ \mathbf{x} &= \hat{\mathbf{k}}x \text{sgn}(\omega). \end{aligned}$$

From this equation, we can see that the plane propagates normal to itself with a phase speed given by

$$v_\phi = |\omega|/k. \quad (48)$$

The direction of this propagation is given by $\hat{\mathbf{k}}\text{sgn}(\omega)$. Thus, we define the *phase velocity* by

$$\mathbf{v}_\phi = v_\phi \hat{\mathbf{k}}\text{sgn}(\omega) = (\omega/k)\hat{\mathbf{k}}. \quad (49)$$

This is the velocity with which planes of constant phase propagate.

In analogy with the one-dimensional case, let us now allow ω to be a function of \mathbf{k} , that is, $\omega = \omega(\mathbf{k})$. We will now consider how a wave composed of the sum of two plane waves of the form of Eq. (42) with nearby values of k might propagate. Thus, let us consider

$$\begin{aligned} u(x, t) &= A \left\{ \exp \left[i \left(\mathbf{k}^+ \cdot \mathbf{x} - \omega^+ t \right) \right] \right. \\ &\quad \left. + \exp \left[i \left(\mathbf{k}^- \cdot \mathbf{x} - \omega^- t \right) \right] \right\}. \end{aligned} \quad (50)$$

In this equation we have used \mathbf{k}^\pm and ω^\pm as shorthand notations for

$$\begin{aligned} \mathbf{k}^\pm &= \bar{\mathbf{k}} \pm \Delta\mathbf{k}, \\ \omega^\pm &= \bar{\omega} \pm \Delta\omega \approx \bar{\omega} \pm \nabla_{\mathbf{k}}\omega(\bar{\mathbf{k}}) \cdot \Delta\mathbf{k} \\ \bar{\mathbf{k}} &= (\mathbf{k}^+ + \mathbf{k}^-)/2, \quad \bar{\omega} = \omega(\bar{\mathbf{k}}). \end{aligned} \quad (51)$$

We have denoted by $\nabla_{\mathbf{k}}$ the gradient of $\omega(\mathbf{k})$ with respect to \mathbf{k} . The dot product occurring in the approximation of $\bar{\omega}$ is the extension to two or three dimensions of the two-term Taylor expansion appearing in Eq. (10).

By using these definitions in Eq. (32) and rewriting that sum in terms of the average $\bar{\mathbf{k}}$ and $\Delta\mathbf{k}$, we obtain the following representation of the superposition of two waves:

$$u(\mathbf{x}, t) = 2A \cos[\Delta\mathbf{k} \cdot (\mathbf{x} - \nabla_{\mathbf{k}}\omega t)] \times \exp[i(\bar{\mathbf{k}} \cdot \mathbf{x} - \bar{\omega}t)]. \quad (52)$$

As in the one-dimensional case, we see that the superposition of the two waves yields a wave at the average wave vector and frequency with an amplitude modulator provided by the perturbations in the average wave vector and frequency. The planes of constant phase of this modulator are of the form

$$\Delta\mathbf{k} \cdot (\mathbf{x} - \nabla_{\mathbf{k}}\omega t) = \text{const.} \quad (53)$$

These planes have normal direction given by $\Delta\mathbf{k}$ and propagate in the direction of $\nabla_{\mathbf{k}}\omega$. Indeed, the velocity of propagation is given by

$$\mathbf{v}_g = \nabla_{\mathbf{k}}\omega \quad (54)$$

which we define to be the *group velocity*. The magnitude of this vector, $|\nabla_{\mathbf{k}}\omega|$, is called the *group speed*. As in the one-dimensional case, we will see below that the group velocity will arise in a natural way when we consider Fourier superpositions of waves in the high frequency limit.

We remark that the phase velocity and the group velocity need not be in the same direction. Indeed, they will only be in the same direction when $\omega = \omega(k)$, that is, when omega is a function of the magnitude k rather than a function of the two or three independent components of \mathbf{k} . We list some examples of both types:

$$\begin{aligned} \omega = ck, & \quad \mathbf{v}_\phi = c\hat{\mathbf{k}}, \quad \mathbf{v}_g = c\hat{\mathbf{k}} \\ \omega = \sqrt{c^2k^2 + b^2}, & \quad \mathbf{v}_\phi = \frac{\sqrt{c^2k^2 + b^2}}{k}\hat{\mathbf{k}}, \\ & \quad \mathbf{v}_g = \frac{c^2k}{\sqrt{c^2k^2 + b^2}}\hat{\mathbf{k}} \\ \omega = \omega_0 k_3/k, & \quad \mathbf{v}_\phi = \omega_0 k_3/k^2 \hat{\mathbf{k}} \\ & \quad \mathbf{v}_g = \omega_0 [-k_3/k^2 \hat{\mathbf{k}} + (0, 0, 1)/k] \\ \omega = ck + Uk_1, & \quad \mathbf{v}_\phi = [c + Uk_1/k] \hat{\mathbf{k}}, \\ & \quad \mathbf{v}_g = c\hat{\mathbf{k}} + (U, 0, 0). \end{aligned} \quad (55)$$

The third example here arises in the modeling of waves in a rotating fluid, and the fourth example arises in the modeling of waves in a transversely moving medium.

As in the one-dimensional case, it is the group velocity, now a vector, that governs the propagation of energy over a distance.

3.2 Fourier superposition

We now consider waves that are the Fourier superposition of plane waves of the type introduced above. Thus, let us set

$$u(\mathbf{x}, t) = \frac{1}{(2\pi)^m} \int_{-\infty}^{\infty} A(\mathbf{k}) \times \exp \{i[\mathbf{k} \cdot \mathbf{x} - \omega(\mathbf{k})t]\} d^m k. \quad (56)$$

In this equation, the domain of integration is understood to be from $-\infty$ to ∞ in all m independent k variables. For our purposes, m will be restricted to 2 or 3.

Such Fourier superpositions can be used to reconstruct a broad class of waves. Below, we describe three quite different types of waves and their corresponding Fourier transforms, $A(\mathbf{k})$, along with the necessary dispersion relation. That is, we will provide the amplitudes of the integrand in (57), as well as the attendant function, $\omega(\mathbf{k})$, needed to complete the integrand in that equation. In all examples, $m = 3$.

The first example is a periodic plane wave in three dimensions

$$u(\mathbf{x}, t) = \cos[\mathbf{k}_0 \cdot \mathbf{x} - ck_0 t],$$

for which

$$\begin{aligned} A(\mathbf{k}) &= A_+(\mathbf{k}) + A_-(\mathbf{k}), \\ A_{\pm}(\mathbf{k}) &= 4\pi^3 \delta(k_1 \mp k_{10}) \delta(k_2 \mp k_{20}) \\ &\quad \cdot \delta(k_3 \mp k_{30}), \\ \omega &= \omega_{\pm}(\mathbf{k}) = \pm ck_0. \end{aligned} \quad (57)$$

Here, upper signs in the last two lines go together, as do the lower signs.

The second example is the Green's function for the wave equation in a homogeneous medium:

$$\begin{aligned} u(\mathbf{x}, t) &= \frac{\delta(t - r/c)}{4\pi r}, \\ r &= \sqrt{x_1^2 + x_2^2 + x_3^2}, \end{aligned}$$

for which

$$\begin{aligned} A(\mathbf{k}) &= A_+(\mathbf{k}) + A_-(\mathbf{k}), \\ A_{\pm}(\mathbf{k}) &= \pm \frac{ic}{2k}, \quad \omega_{\pm}(\mathbf{k}) = \pm ck. \end{aligned} \quad (58)$$

It should be noted that the singularity, $1/k$, in these amplitudes is actually quite mild in three dimensions, owing to the fact that the differential volume element, written in spherical polar coordinates is $k^2 \sin \theta dk d\theta d\phi$. The multiplication by k^2 in the inverse transform assures that the volume integral will not be singular at $k = 0$.

Note also, that if this representation is derived as the solution of a *causal* problem, that is, one for which $u = 0$ for $t < 0$, then it should only be used for $t > 0$. If not, it will actually yield a second wave, $\delta(t + r/c)/4\pi r$, propagating backwards in time! Use of a causal inverse Fourier transform in time will assure that this wave does not arise. Discussion of causal Fourier transforms is beyond the scope of this article.

The last example is the distributional plane wave.

$$u(\mathbf{x}, t) = \delta(x_1 - ct)$$

for which

$$A(\mathbf{k}) = (2\pi)^2 \delta(k_2) \delta(k_3),$$

$$\omega(\mathbf{k}) = ck_1. \tag{59}$$

3.3 Multidimensional stationary phase formula

In Eq. (57) we cannot as easily write down a closed-form recognizable function representing the wave propagating in space and time. In this case, we again resort to the method of stationary phase, this time *multidimensional stationary phase*, to approximate the multifold wave form in terms of more familiar plane waves of the form of Eq. (43) for arbitrary $A(\mathbf{k})$. First, we present the multidimensional stationary phase formula.

Let us suppose that the integral I is defined by

$$I(\Lambda) = \int f(\boldsymbol{\eta}) \exp[i\Lambda\Phi(\boldsymbol{\eta})] d^m \boldsymbol{\eta}. \tag{60}$$

In this equation, the single integral sign is understood to represent an m -fold integral over the m variables, $\eta_1, \eta_2, \dots, \eta_m$. We are interested in an approximation of the integral for large values of Λ .

As in one dimension, the integral is dominated by contributions from the neighborhoods of certain critical points, $\boldsymbol{\eta}_1, \boldsymbol{\eta}_2, \dots, \boldsymbol{\eta}_n$, called *stationary points*, where

$$\partial\Phi(\boldsymbol{\eta})/\partial\eta_p = 0, \quad p = 1, 2, \dots, m$$

$$\boldsymbol{\eta} = \boldsymbol{\eta}_j, \quad j = 1, 2, \dots, n.$$

This is the generalization of the condition of Eq. (15).

A stationary point are called simple when *the Hessian matrix*, the matrix of second derivatives, has a nonzero determinant at that point. That is,

$$\det [\Phi_{pq}(\boldsymbol{\eta}_j)] \neq 0; \quad \Phi_{pq}(\boldsymbol{\eta}) = \partial^2\Phi(\boldsymbol{\eta}_j)/\partial\eta_p \partial\eta_q$$

$$p, q = 1, 2, \dots, m, \quad j = 1, 2, \dots, n. \tag{61}$$

The integral I is then approximated by

$$I \sim \sum_{j=1}^n \left(\frac{2\pi}{|\Lambda|} \right)^{m/2} \frac{f(\boldsymbol{\eta}_j)}{\sqrt{|\det[\Phi_{pq}(\boldsymbol{\eta}_j)]|}} \times \exp \left[i\Lambda \Phi(\boldsymbol{\eta}_j) + i(\pi/4) \text{sgn}(\Lambda) \text{Sgn}(\Phi_{pq}(\boldsymbol{\eta}_j)) \right]. \tag{62}$$

In this equation, $\text{Sgn}(\Phi_{pq})$ denotes the signature of the matrix $[\Phi_{pq}]$. The signature of a matrix is the number of positive eigenvalues minus the number of negative eigenvalues of the matrix. This result is the multidimensional stationary phase formula.

The qualitative description of the method of stationary phase is completely analogous to the discussion of the one-dimensional case. Each term in the sum in Eq. (63) is an approximation to the integral in a small domain around the stationary point.

As in the one-dimensional case discussed in Chapter 1, a dimensionless large parameter Λ can be identified for integrals of the type in Eq. (57) by recasting that integral in dimensional variables in terms of dimensionless variables. However, we will proceed formally to use this approximation in the dimensional integral of Eq. (57) with the formal large parameter equal to unity. As we demonstrated in Section 1, this will produce an asymptotic approximation valid for large time measured in units of a characteristic time of the integral or large distance measured in a characteristic distance of the integral.

3.4 Asymptotic analysis of Fourier superposition

We will now apply the multidimensional stationary phase formula of Eq. (63) to the integral of Eq. (57). To do so, we introduce the phase function

$$\Phi(\mathbf{k}) = \mathbf{k} \cdot \mathbf{x} - \omega(\mathbf{k})t. \tag{63}$$

In order to use this method, both the first and second derivatives of this phase function are needed. Those derivatives are They are

$$\begin{aligned} \frac{\partial \Phi(\mathbf{k})}{\partial k_p} &= x_p - \frac{\partial \omega(\mathbf{k})}{\partial k_p} t \\ \frac{\partial^2 \Phi(\mathbf{k})}{\partial k_p \partial k_q} &= -\frac{\partial^2 \omega(\mathbf{k})}{\partial k_p \partial k_q} t = -\omega_{pq}(\mathbf{k})t \\ p, q &= 1, 2, \quad \text{or} \quad 1, 2, 3. \end{aligned} \tag{64}$$

The stationary points are determined by setting the first derivatives of Φ equal to zero. We write that result in the vector form,

$$\mathbf{x} = \nabla_{\mathbf{k}} \omega(\mathbf{k})t. \tag{65}$$

The vector on the right side, $\nabla_{\mathbf{k}}\omega(\mathbf{k})$ can be recognized as the *group velocity vector* introduced earlier. For a particular choice of (\mathbf{x}, t) , the stationary points in \mathbf{k} are those points for which the group velocity is the velocity of propagation from the origin to \mathbf{x} in the time t . We remark that with more structure in $A(\mathbf{k})$ (for example, some phase dependence), we could create examples in which the propagation is not from the origin but from other points in space. In any case, the velocity of propagation picked out by the condition of stationarity would remain the group velocity. Again, as in one dimension, the contribution from each stationary point, that is, each solution of Eq. (65), approximates the integral in a local domain around the stationary point. Thus, each such contribution represents the propagation of a packet of wave vectors in a neighborhood of the particular wave vector satisfying Eq. (65).

The asymptotic approximation to Eq. (57) in the form of Eq. (63) is

$$\begin{aligned}
 u(\mathbf{x}, t) \sim & \sum_{j=1}^n \frac{1}{(2\pi t)^{3/2}} \frac{A(\mathbf{k}_j)}{\sqrt{|\det[\omega_{pq}(\mathbf{k}_j)]|}} \\
 & \times \exp\left\{i[\mathbf{k}_j \cdot \mathbf{x} - \omega(\mathbf{k}_j)t] \right. \\
 & \left. -i(\pi/4)\text{Sgn}(\omega_{pq}(\mathbf{k}_j))\right\}, \\
 \mathbf{x} = & \nabla_{\mathbf{k}}\omega(\mathbf{k}_j)t.
 \end{aligned} \tag{66}$$

We see here that asymptotically each term of this general wave form behaves locally as a plane wave propagating at a group velocity which, in general, will vary from point to point in space. This is an essential feature of high frequency propagation of waves. Thus, the propagation of plane waves takes on an added significance as the local propagation of more complex wave structures.

As in the one-dimensional case, we see in the structure of this representation a wave with recognizable crests—which are the phase surfaces of the exponential—and slowly varying amplitude.

The propagation paths along which the solution propagates Eq. (65) turn out to be the rays of geometrical optics, a high frequency technique based on the WKB method for ordinary differential equations. For continuous gradient functions $\nabla_{\mathbf{k}}\omega(\mathbf{k})$, the rays for a packet of nearby \mathbf{k} values will remain near to one another and will fill out a cone (not necessarily of circular cross section) as time progresses.

This observation leads to the interpretation of the solution representation as an example of energy conservation. Returning to the representation of Eq. (57) and setting $t = 0$, we see that $A(\mathbf{k})$ can be interpreted as the spectral density of the initial data. We then think of the square of this quantity, $|A(\mathbf{k})|^2$, as being the spectral density of the energy in the k domain or $|A(\mathbf{k})|^2\Delta V_{\mathbf{k}}$ as the energy in the packet of k values in the volume element $\Delta V_{\mathbf{k}}$ around \mathbf{k} .

Let us define $|A(\mathbf{k}, t)|$ to be the amplitude of the wave $u(\mathbf{x}, t)$ at fixed \mathbf{k} as time progresses. In this expression of the amplitude, we define the \mathbf{x} -coordinate associated with \mathbf{k} by the ray equation Eq. (65). Thus, $|A(\mathbf{k}, 0)|$ is just the spectral density $|A(\mathbf{k})|$. In an energy conserving system, we expect that as the wave propagates, $|A(\mathbf{k}, t)|^2\Delta V_{\mathbf{k}}(\mathbf{k}, t)$ will be preserved (that is, remain constant) while the volume element varies in accordance with the ray equation Eq. (65). The product $t^3|\det(\omega_{pq}(\mathbf{k}))|$ is the Jacobian of transformation

via rays and is proportional to this volume element. Thus, for the energy to be preserved in a packet of k values, the energy density $|A(\mathbf{k}, t)|^2$ must vary inversely with this Jacobian, and the amplitude $|A(\mathbf{k}, t)|$ of the wave must therefore vary inversely with the square root of this Jacobian. This provides a physical interpretation of the division by the square root of the Hessian matrix in the asymptotic expressions of the summand in Eq. (66a) and our interpretation of the solution formula as a manifestation of conservation of energy. It is also consistent with our earlier claim that energy propagates at the group velocity.

3.5 Plane waves: Reflection and refraction

Fundamental to the set of concepts of how plane waves propagate is the interaction of such waves with a planar boundary across which some property of the medium of propagation [equivalently, some coefficient(s) of the modeling equation(s)] changes. We will describe this phenomenon in the context of a specific example and then discuss generalizations of the basic result.

Let us suppose that we are considering plane waves that are solutions of the wave equation

$$c^2 \left[\frac{\partial^2 u}{\partial x_1^2} + \frac{\partial^2 u}{\partial x_2^2} + \frac{\partial^2 u}{\partial x_3^2} \right] - \frac{\partial^2 u}{\partial t^2} = 0$$

$$c = \begin{cases} c_-, & x_1 < 0 \\ c_+, & x_1 > 0 \end{cases} . \quad (67)$$

We wish to consider the interaction of a plane wave at a fixed frequency, incident on the interface at $x_1 = 0$ from the left; that is, from the medium in which $c = c_-$. Thus, we anticipate an incident wave, which we will denote by u_I of the form,

$$u_I(\mathbf{x}, t) = A_I \exp\{i[(\mathbf{k}_I \cdot \mathbf{x} - \omega(\mathbf{k}_I)t)]\}. \quad (68)$$

In this equation, we must choose $\omega(\mathbf{k})$ so that the plane wave satisfies the governing Eq. (67). Thus,

$$\omega^2 = c_-^2 k_I^2, \quad \omega = \pm c_- k_I. \quad (69)$$

Of the two choices, we will set $\omega = c k_I$. This was the first example of a dispersion relation in Eq. (55). With this choice, both the phase velocity and the group velocity have the same direction as \mathbf{k}_I ; for the opposite choice, the two velocities would be directed opposite to \mathbf{k}_I . Thus, so that our plane wave is propagating from $x_1 < 0$ toward $x_1 = 0$, \mathbf{k}_I must make an acute angle with the x_1 axis. That is,

$$k_{1I} > 0, \quad \omega = c k_I. \quad (70)$$

We will conjecture that the total solution in $x_1 < 0$ is made up of the incident wave and another wave called the *reflected wave* (u_R). Furthermore, we will assume that another plane wave is transmitted (u_T) through the interface. Thus, we conjecture a total solution of the

form

$$\begin{aligned}
 u(\mathbf{x}, t) &= \begin{cases} u_I(\mathbf{x}, t) + u_R(\mathbf{x}, t), & x_1 < 0 \\ u_T(\mathbf{x}, t), & x_1 > 0 \end{cases} \\
 u_R(\mathbf{x}, t) &= A_R \exp\{i[\mathbf{k}_R \cdot \mathbf{x} - \omega_R t]\} \\
 u_T(\mathbf{x}, t) &= A_T \exp\{i[\mathbf{k}_T \cdot \mathbf{x} - \omega_T t]\}.
 \end{aligned} \tag{71}$$

Our objective now is to express ω_R , ω_T , \mathbf{k}_R , \mathbf{k}_T , A_R , and A_T in terms of \mathbf{k}_I and A_I . That is, we seek to express the frequencies, the directions of propagation, and the amplitudes of the reflected and transmitted waves in terms of the same parameters for the incident wave and conditions imposed on the model as to how these waves are to interact at the boundary.

A typical requirement of such interactions is that the solution be continuous across the interface. That is,

$$\begin{aligned}
 &A_I \exp[i(k_{2I}x_2 + k_{3I}x_3 - c_-k_I t)] \\
 &\quad + A_R \exp[i(k_{2R}x_2 + k_{3R}x_3 - \omega_R t)] \\
 &= A_R \exp[i(k_{2T}x_2 + k_{3T}x_3 - \omega_T t)].
 \end{aligned} \tag{72}$$

We take the Fourier transform of this equation with respect to t , that is, we multiply by $\exp(i\mu t)$ and integrate from $-\infty$ to ∞ with respect to t , and we find that all frequencies must agree. This follows from the fact that the first integral is proportional to $\delta(\mu - ck_I)$, while the second is proportional to $\delta(\mu - \omega_R)$ and the third is proportional to $\delta(\mu - \omega_T)$. Since each of these Dirac delta functions is nonzero only where its argument is zero, they could not agree unless the frequencies were the same. Thus,

$$\omega_R = c_-k_R = \omega_T = c_+k_T = c_-k_I. \tag{73}$$

By a completely analogous argument applied to the spatial transforms, we find also that

$$k_{2R} = k_{2T} = k_{2I} \text{ and } k_{3R} = k_{3T} = k_{3I}. \tag{74}$$

These equations state that the projections of the three wave vectors on the planar interface must agree. The previous equation, in addition to equating the frequencies, states that the magnitudes of the reflected wave vector must equal the magnitude of the incident wave vector, while the magnitude of the transmitted wave vector must equal these two up to a scale factor.

Let us first focus our attention on \mathbf{k}_R , the reflected wave vector. From Eqs. (73) and (74) it follows that $k_{1R} = \pm k_{1I}$. If these two components had the same sign, then \mathbf{k}_R would equal \mathbf{k}_I and the reflected wave would also be directed toward the interface. On physical grounds, we reject this; we expect u_R to be a wave directed away from the interface. The mathematical basis for rejecting this case is equally strong. Were we to continue, we would find that A_R would be the negative of A_I and A_T would be zero. That is, a total solution

that is identically zero would result. This is not the solution of interest. Thus, whether on mathematical grounds or physical grounds, we set

$$k_{1R} = -k_{1I}. \quad (75)$$

We see then that the incident and reflected wave vectors differ only in the sign of the normal component. Thus, these two vectors must make equal angles with the normal vector to the interface. This is Snell's law of reflection.

Let us now consider the parameters for the transmitted wave. We denote by K_I and K_T , respectively, the magnitudes of the transverse components of the wave vectors \mathbf{k}_I and \mathbf{k}_T :

$$K_I = \sqrt{k_{2I}^2 + k_{3I}^2}, \quad K_T = \sqrt{k_{2T}^2 + k_{3T}^2}. \quad (76)$$

From Eq. (74), we see that these two magnitudes are equal. Furthermore, dividing this equality by the last part of Eq. (73) yields

$$\frac{K_I}{c_- k_I} = \frac{K_T}{c_+ k_T}. \quad (77)$$

This is Snell's law of refraction, and the transmitted wave is, in fact, the refracted wave. The law is more often expressed in terms of the angles of incidence and refraction, these being the angles that the wave vectors make with the normal to the interface. If we denote those angles by I and R , respectively, then

$$\sin I = K_I/k_I, \quad \sin R = K_T/k_T. \quad (78)$$

Thus, we conclude from Eqs. (77) and (78) that

$$\sin R / \sin I = c_+ / c_-. \quad (79)$$

This is Snell's law of refraction in more familiar form. In order that R be a real angle, we must require that $\sin R$ be less than or equal to unity. Equivalently, we require that $(c_+/c_-) \sin I \leq 1$. When this criterion is violated (only possible for $c_+ > c_-$), we do not have a wave of the form of Eq. (72) propagating in the second medium.

We now determine k_{1T} . From Eq. (73), we can see that

$$k_T^2 = k_{1T}^2 + k_{2T}^2 + k_{3T}^2 = c_-^2 k_I^2 / c_+^2. \quad (80)$$

We know k_{2T} and k_{3T} from Eq. (74). Thus, we can determine k_{1T} within a sign. We require that u_T be a wave propagating away from the interface. Thus, k_{1T} must be positive, and the solution for k_{1T} is

$$\begin{aligned} k_{1T} &= \sqrt{k_I^2 c_-^2 / c_+^2 - k_{2I}^2 - k_{3I}^2} \\ &= k_I \sqrt{c_-^2 / c_+^2 - \sin^2 I}. \end{aligned} \quad (81)$$

Our assumption that the angle of refraction be real assures us that k_{1T} is real. We can now see that when this criterion is violated, k_{1T} is imaginary and an *attenuated or evanescent wave* propagates in the second medium.

In summary, determination of the direction of propagation of the reflected and refracted wave rests totally on the matching of the phases at the interface. Thus, even under conditions which require that some multiple of $u(\mathbf{x}, t)$ on both sides of the interface be equal, the same conclusion would be reached. Furthermore, we can state this result in more general terms. First, Eq. (73) tells us that the frequencies of all of the waves must agree at the interface. Since the frequency is related to the wave vectors through the dispersion relation, we obtain one equation relating the wave vector \mathbf{k}_R to \mathbf{k}_I and another relating \mathbf{k}_T to \mathbf{k}_I . In general, these equations are nonlinear. Equation (74) may be viewed as prescribing that the projections of all of the wave vectors on the interface (i.e., the transverse part of the wave vectors) must agree. This provides another pair of equations for the components of \mathbf{k}_R and another pair of equations for the determination of \mathbf{k}_T . Indeed, this determines the transverse components of the wave vectors, and only the normal component remains to be determined. It is in this normal component that all of the change from \mathbf{k}_I in the structure of the wave vectors can occur. Finally, we observe that for our high frequency approximation [Eq. (66)] to the general Fourier superposition, the same result obtains in a pointwise manner at the interface. These features are common to all linear wave phenomena.

To determine the amplitudes A_R and A_T in Eq. (72), we need a second relationship between the solutions on the two sides of the interface. We will impose the condition that the normal derivatives of the fields be equal at the interface. For our specific example of an interface at $x_1 = 0$, the normal derivative is the x_1 derivative. We will differentiate the two representations of $u(\mathbf{x}, t)$ in Eq. (72) and then set x_1 equal to zero. We exploit what we already know about the wave vectors and frequency to simplify this expression. We also use Eq. (72) with the same simplifications. This leads to a pair of equations in the two unknowns A_R and A_T . Those equations are

$$A_I + A_R = A_T \tag{82}$$

$$k_{1I}A_I - k_{1I}A_R = k_{1I}\sqrt{c_-^2/c_+^2 - \sin^2 I}A_T.$$

The solution of this pair of equations is

$$A_R = RA_I, \quad A_T = TA_I \tag{83}$$

where R and T are, respectively, the *reflection coefficient* and *transmission coefficient*, which relate the amplitudes A_R and A_T to A_I . They are given by

$$R = \frac{1 - \sqrt{c_-^2/c_+^2 - \sin^2 I}}{1 + \sqrt{c_-^2/c_+^2 - \sin^2 I}} \tag{84}$$

$$T = \frac{2}{1 - \sqrt{c_-^2/c_+^2 - \sin^2 I}}.$$

The value of $\sin I$ in terms of \mathbf{k}_I is given by Eq. (78). At normal incidence, that is, when

the angle I is zero, $\sin I = 0$, these coefficients reduce to

$$\begin{aligned} R &= \frac{c_+ - c_-}{c_+ + c_-} \\ T &= \frac{2c_+}{c_+ + c_-}. \end{aligned} \tag{85}$$

Bibliography

- Aki, K., and P., Richards, (1980). "Quantitative Seismology: Theory and Methods" vols. 1 and 2. Freeman, New York.
- Bleistein, N. (1984). "Mathematical Methods for Wave Phenomena." Academic Press, New York.
- Bleistein, N., R. A. Handelsman, (1986). "Asymptotic expansions of integrals." Dover Publications Inc., New York.
- Bleistein, N., J. K. Cohen, J. W. Stockwell, Jr., (2000). "Mathematics of Multidimensional Imaging, Migration and Inversion." Springer-Verlag, New York.
- Brekhovskikh, L. M., O. A. Godin, (1998). "Acoustics of Layered Media I : Plane and Quasi-Plane Waves." Springer-Verlag, New York.
- Brillouin, L. (1960). "Wave Propagation and Group Velocity." Academic Press, New York.
- Brillouin, L. (1953). "Wave Propagation in Periodic Structures." Dover, New York.
- Erdélyi, A., (1954). "Asymptotic Expansions of Integrals." Dover Publications Inc., New York.
- Ewing, W. M., Jardetzky, W. S., and Press, F. (1957). "Elastic Waves in Layered Media." McGraw Hill, New York.
- Felsen, L. B., and Marcuvitz, N. (1973). "Radiation and Scattering of Waves." Prentice Hall, Englewood Cliffs, New Jersey.
- Goodman, J. W. (1968). "Introduction to Fourier Optics." McGraw Hill, New York.
- Jackson, J. D., (1998) "Classical Electrodynamics, 3rd Ed." John Wiley & Sons, New York.
- Pekeris, C. L. (1963). Theory of propagation of explosive sound in shallow water, In "Propagation of Sound in the Ocean," *Geol. Soc. Am. Memoir 27*.
- Sommerfeld, A. (1964). "Optics, Lectures on Theoretical Physics, vol. 4." Academic Press, New York.

Stoker, J. J. (1957). "Water Waves," Wiley (Interscience), New York.

Titchmarsh, E. C., (1948). "Introduction to the theory of Fourier integrals." Clarendon, Oxford.

Whitham, G. B. (1974). "Linear and Nonlinear Waves," Wiley, New York.